



AUTOGRU

AU 42 TB - RC 40

Specifiche

Portata massima a 3.00 mt	42000 kg
Altezza massima di sollevamento testa braccio	29.5 mt
Lunghezza braccio chiuso/aperto	9.1/27.4 mt
Trazione	4x4x4
Tipo di braccio	4 elementi ultimo manuale
Prolunga tralicciata	Non disponibile
Peso	27800 kg ca
Lunghezza	10.93 mt
Lunghezza del carro	6.88 mt
Larghezza chiusa	2.55 mt
Larghezza stabilizzata	5.83 mt
Altezza	3.45 mt
Passo (interasse)	3.62 mt
Raggio di sterzata esterno alle ruote	N.D.
Altezza dal suolo	0.41 mt
Rotazione torretta	360° continua
Motore	Turbo 119* kw
Trasmissione	Powershift
Modi di sterzata	Coordinata/ Anteriore/a granchio
Serbatoio carburante	240 L
Pneumatici	16.00 R 25
Velocità massima su strada	34 km

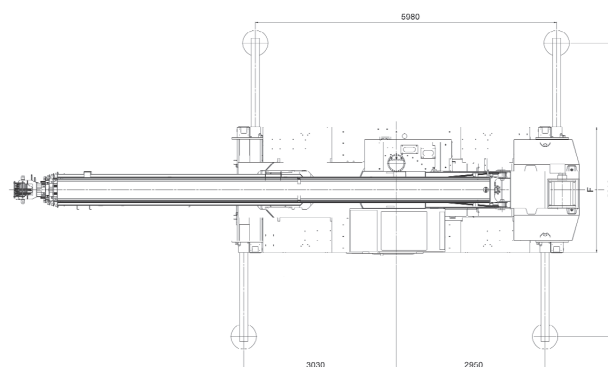
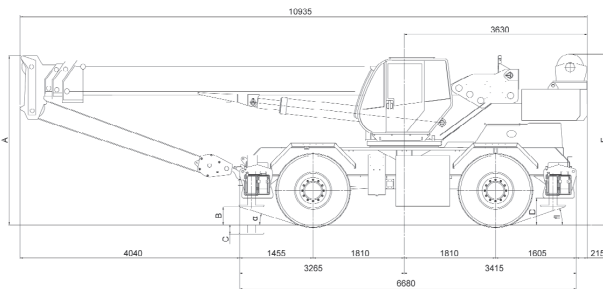
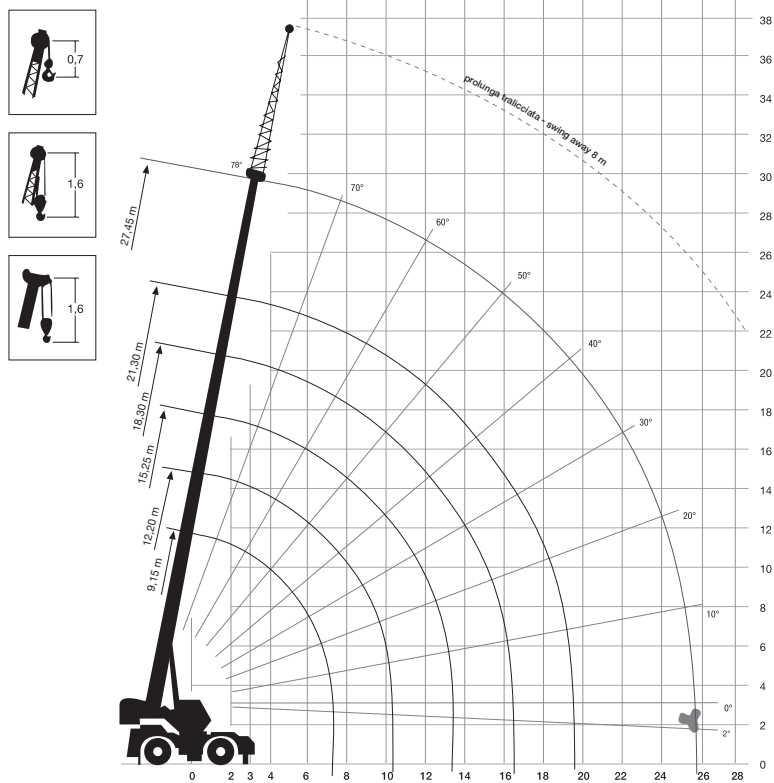

* I dati tecnici riportati sono di carattere commerciale e indicativi, i dati di riferimento effettivi si trovano sul manuale d'uso e manutenzione del mezzo



NOLEGGIO

VENDITA

FORMAZIONE

ASSISTENZA

LocaTop

L'ALTEZZA SEMPRE PIÙ A PORTATA DI MANO

5.80 m	9.15 m ÷ 27.45 m	5.50 t	360°	

	t2 = 0%t	2 = 25%t	2 = 50%t	2 = 75%t	2 = 100%t	2 = 100%	
	t3 = 0%t	3 = 25%t	3 = 50%t	3 = 75%t	3 = 100%t	3 = 100%	
	t4 = 0%t	4 = 0%	t4 = 0%t	4 = 0%	t4 = 0%t	4 = 100%	
	9.15 m	12.20 m	15.25 m	18.30 m	21.35 m	27.45 m	
3.0	42.00	26.10	23.90	22.45			3.0
3.5	36.90	27.65	24.90	22.20	12.00		3.5
4.0	31.90	29.00	24.40	20.40	11.45		4.0
4.5	26.30	26.10	22.70	19.00	10.90	13.70	4.5
5.0	24.60	23.60	21.30	17.80	10.35	12.65	5.0
6.0	19.40	19.60	18.90	15.60	9.80	10.95	6.0
7.0	14.50	14.75	14.80	13.90	9.25	9.40	7.0
8.0		11.35	11.40	11.45	8.75	8.25	8.0
9.0		9.05	9.15	9.25	7.75	7.40	9.0
10.0		7.40	7.50	7.50	6.95	6.65	10.0
11.0			6.25	6.30	6.30	6.00	11.0
12.0			5.30	5.35	5.35	5.45	12.0
13.0			4.50	4.55	4.60	5.00	13.0
14.0				3.90	3.90	4.40	14.0
15.0				3.40	3.40	3.85	15.0
16.0				2.90	2.90	3.40	16.0
17.0					2.55	3.05	17.0
18.0					2.20	2.70	18.0
19.0					1.90	2.40	19.0
20.0						2.15	20.0
21.0						1.90	21.0
22.0						1.70	22.0
23.0						1.50	23.0
24.0						1.35	24.0
25.0						1.20	25.0





* I dati tecnici riportati sono di carattere commerciale e indicativi, i dati di riferimento effettivi si trovano sul manuale d'uso e manutenzione del mezzo













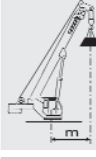



- NOLEGGIO**
- VENDITA**
- FORMAZIONE**
- ASSISTENZA**

LocaTop

L'ALTEZZA SEMPRE PIÙ A PORTATA DI MANO

				
16.0R25/20 R25	0 Km/h	360°	0 Km/h	0°

	t2= 0%	t2= 25%	2= 50%	2= 75%	2= 100%	t2= 0%	t2= 25%	2= 50%	2= 75%	2= 100%	
	t3= 0%	t3= 25%	3= 50%	3= 75%	3= 100%	t3= 0%	t3= 25%	3= 50%	3= 75%	3= 100%	
	t4= 0%	t4= 0%	t4= 0%	t4= 0%	t4= 0%	t4= 0%	t4= 0%	t4= 0%	t4= 0%	t4= 0%	
	9.1m	12.2m	15.2m	18.3m	21.3m	9.1m	12.2m	15.2m	18.3m	21.3m	
											
3.0	11.85					16.90	16.95	16.95	16.95		3.0
3.5	10.20					15.05	15.10	15.10	15.10	12.00	3.5
4.0	8.55					13.25	13.30	13.30	13.30	11.45	4.0
4.5	7.50	7.55				11.95	12.00	12.05	12.00	10.90	4.5
5.0	6.60	6.70				10.90	10.95	10.95	11.00	10.35	5.0
6.0	4.90	5.00	5.00			8.80	8.85	8.90	8.90	8.90	6.0
7.0	3.50	3.65	3.70	3.70		7.35	7.50	7.55	7.55	7.60	7.0
8.0		2.75	2.80	2.85			5.85	5.90	5.95	5.95	8.0
9.0		2.10	2.15	2.20	2.20		4.60	4.65	4.80	4.80	9.0
10.0		1.55	1.65	1.70	1.70		3.70	3.80	3.85	3.85	10.0
11.0			1.25	1.25	1.30			3.10	3.15	3.15	11.0
12.0			0.90	0.95	0.95			2.55	2.60	2.65	12.0
13.0			0.60	0.65	0.65			2.10	2.15	2.20	13.0
14.0				0.40	0.45				1.75	1.80	14.0
15.0				0.20	0.20				1.45	1.50	15.0
16.0				0.03	0.05				1.15	1.20	16.0
17.0										0.95	17.0
18.0										0.75	18.0
19.0										0.55	19.0
20.0											20.0
21.0											21.0
22.0											22.0
23.0											23.0
24.0											24.0
25.0											25.0

* I dati tecnici riportati sono di carattere commerciale e indicati in i, i dati di riferimento effettivi si trovano sul manuale d'uso e manutenzione del mezzo



NOLEGGIO
VENDITA
FORMAZIONE
ASSISTENZA

LocaTop

L'ALTEZZA SEMPRE PIÙ A PORTATA DI MANO

16.00R25/20.5R22 Km/h	0°	5.8m	9.15m÷ 27.45m	5.5t	360°	8.00m ÷ 14m	

	t2= 0%						L+ 8.0m 0°		L+ 8.0m 20°		L+ 14.0m 0°		L+ 14.0m 20°	
	t3= 0%	t3= 25%	t3= 50%	t3= 75%	t3= 100%		∠	∠	∠	∠	∠	∠	∠	∠
	9.1m	12.2m	15.2m	18.3m	21.3m		Max 78°	5.00	Max 78°	2.40	Max 78°	2.40	Max 78°	1.10
							77°	5.00	78°	2.40	75°	2.40	77°	1.10
							75°	4.20	76°	2.30	73°	2.20	74°	1.05
							74°	4.10	74°	2.25	70°	2.00	70°	1.00
							72°	4.00	72°	2.20	67°	1.80	67°	0.95
							70°	3.80	71°	2.15	64°	1.60	64°	0.90
							68°	3.50	69°	2.10	61°	1.40	61°	0.85
							67°	3.20	67°	2.05	58°	1.30	57°	0.80
							65°	3.00	65°	2.00	55°	1.20	53°	0.75
							63°	2.80	63°	1.95	51°	1.10	50°	0.70
							61°	2.65	62°	1.90	47°	1.00		
							59°	2.50	60°	1.85	44°	0.90		
							58°	2.35	58°	1.80				
							56°	2.20	56°	1.75				
							54°	2.10	53°	1.70				
							52°	2.00	51°	1.65				
							49°	1.90	49°	1.60				
							47°	1.70	47°	1.55				
							45°	1.60	44°	1.40				
							43°	1.45	42°	1.30				
							40°	1.30	39°	1.15				
							38°	1.15	36°	1.00				
							35°	1.05	33°	0.85				
							32°	0.90	29°	0.75				
							29°	0.80	25°	0.65				
							25°	0.70	19°	0.55				
							21°	0.60	11°	0.45				
							16°	0.55						
							8°	0.45						
							0.0	0.40	0.0	0.40	0.0	0.40	0.0	0.40

* I dati tecnici riportati sono di carattere commerciale e indicativi, i dati di riferimento effettivi si trovano sul manuale d'uso e manutenzione del mezzo



NOLEGGIO

VENDITA

FORMAZIONE

ASSISTENZA

www.locatop.it